

Article number: 12706000140110

Description: KLEE-coil 706 000 140.110
M14 Unhardened, zinc-pl. & chr. blue

Measures

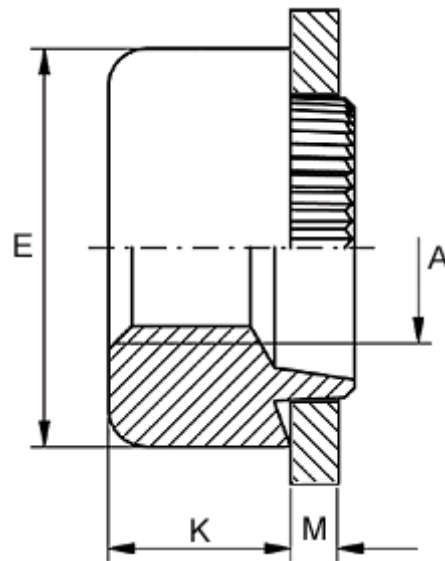

Female thread A	= M14
Height K	= 10.0
Outer diameter E	= 25.0
Plate thickness	= 1.4 to 1.6
Recommended bore diameter for extreme load	= 19.0
Recommended bore diameter for normal use	= 20.0